

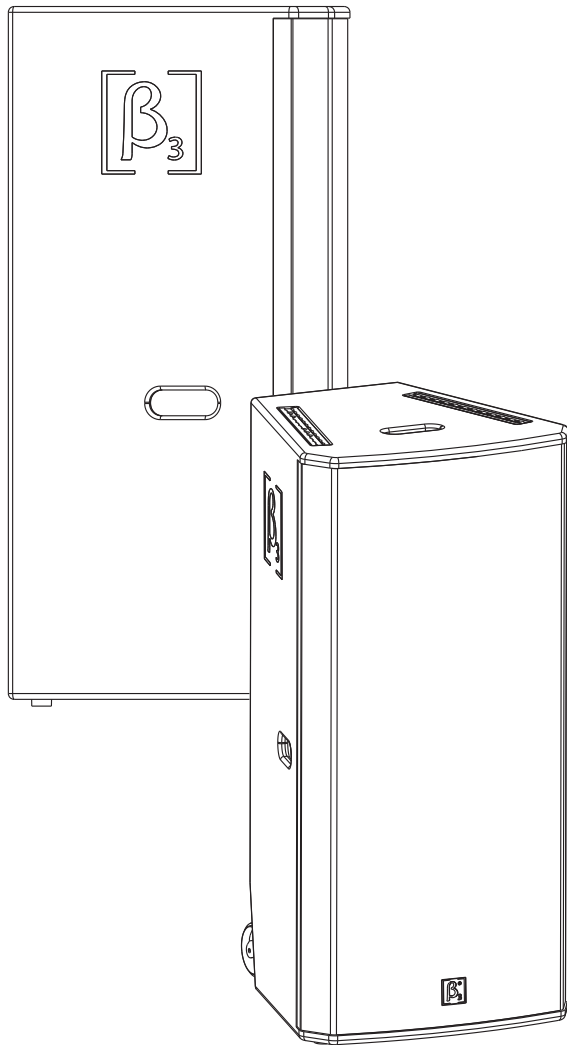

Beta Three



# MU215

Two Way Full Range  
Speaker With Dual 15" Woofers

MU Series Pro Loudspeaker System

## User Manual





UM-MU215-20180105 Ver B



# SAFETY INSTRUCTIONS

## PLEASE READ THIS MANUAL FIRST

Thank you for a buying  $\beta_3$  product. Read this manual first as it will help you operate the system properly. Please keep this manual for future reference.

**⚠ WARNING:** *This product must be installed by professionals. When using hanging brackets or rigging other than those supplied with the product, please ensure they comply with the local safety codes.*

	<b>CAUTION</b> RISK OF ELECTRICAL SHOCK DO NOT OPEN	
CAUTION: TO REDUCE THE RISK OF ELECTRIC SHOCK, DO NOT REMOVE COVER (OR BACK). NO USER-SERVICABLE PARTS INSIDE. REFER SERVICING TO QUALIFIED PERSONNEL.		

	<b>AVIS</b> RISQUE DE CHOC ÉLECTRIQUE NE PAS OUVRIR	
ATTENTION : POUR RÉDUIRE LE RISQUE DE DÉCHARGE ÉLECTRIQUE, NE RETIREZ PAS LE COUVERCLE (OU L'ARRIÈRE). IL NE SE TROUVE À L'INTÉRIEUR AUCUNE PIÈCE POUVANT ÊTRE RÉPARÉE PAR L'USAGER. S'ADRESSER À UN RÉPARATEUR COMPÉTENT.		

 **The exclamation point within an equilateral triangle is intended to alert you to the presence of important operating and servicing instructions.**

**⚠ ATTENTION:** *Don't refit the system or spare parts without being authorized as this will void the warranty.*

**⚠ WARNING:** *Don't place naked flames (such as candles) close to the equipment.*

1. Read the instruction manual first before using this product.
2. Please keep this manual for future reference
3. Pay attention to all warnings.
4. Obey all operating instructions.
5. Do not expose this product to rain or moisture.
6. Clean this equipment with a dry cloth.
7. Do not block any ventilation openings. Install according to manufacturer's instructions .
8. Do not install this product near any heat source, such as a, heater, burner, or any other equipment with heat radiation .
9. Only use spare parts supplied by the manufacturer.
10. Pay attention to the safety symbol on the outside of the cover.

**CONTENT**

**INTRODUCTION** ..... 3

- Features ..... 3
- Description ..... 3
- Applications ..... 3

**CONNECTION** ..... 4

- Terminal Plate ..... 4
- NL4 Connection ..... 4
- System Connection Reference ..... 4
- Loudspeaker Connection ..... 5

**INSTALLATION** ..... 6

- Mounting Accessories ..... 6
- Installation Reference ..... 6

**TECHNICAL SPECIFICATION** ..... 7

- Technical Sheet ..... 7
- Frequency Response And Impedance Curve ..... 7
- 2D Dimension ..... 8

 Product information may be updated without notification, please visit [www.elderaudio.com](http://www.elderaudio.com) for latest update.

# MU215

Built-in crossover dual 15" full range speaker

## Features

- Two way full range phase inverted speaker with double 15" woofers and 3" compression driver.
- Dispersion 90°x40°.
- Advanced free protection crossover assure the reliability of driver.
- Sensitivity 98dB, Max. SPL 126dB.
- Rated power 600W, Peak power 2400W.
- Standard flying mounting system.
- Single plying point can bear 385Kg, which is very safe for the installation.
- Q235 grille is coated by powder to provide strong ultra-Weatherability, can be used outdoors for 5 years. The backside foam of grille can prevent the rain.
- Advanced paint materials and the painting technology make the surface very rigid.

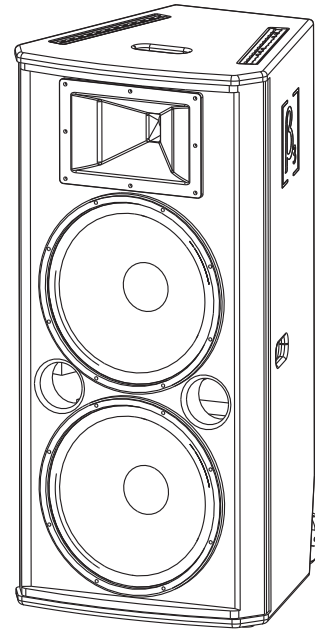

## Description

β<sub>3</sub> MU215 is a full range speaker with dual 15" Neodymium woofers and 3" compression driver in the MU family. The single woofer can delivery 300W power with 3" round copper wire voice coil, symmetrical magnet circuit design reduce the impar HD effectively and enhance the LF sound quality.

Neodymium transducers reduce 15% weight.

Cabinet is made of 18mm birch plywood with advanced environmental protection. Polyurethane-based painting which is very rigid. The cabinet strength reach to 4500N. Q235 grille is coated by powder to provide strong ultra-Weatherability, can be used outdoors for 5 years. The backside foam of grille can prevent the rain.

MU215 adopt the protection free design, which reduce the interfere and enhance the sound quality.

A lot of new materials were used on MU215, for example, the diaphragm is made from magnalium to meet the sound . requirement.

MU215 is mainly designed for conference room, multifunctional hall, auditorium, church, living performance.

Two 4" wheels are very convenient for transportation.

## Applications

- Church
- Auditorium
- Small Performance
- Multifunctional Hall
- Medium Conference Room

Two NL4 connectors are available for amplifier connection. Paralleled connector is very convenient for another speaker connection.

**Terminal Plate**

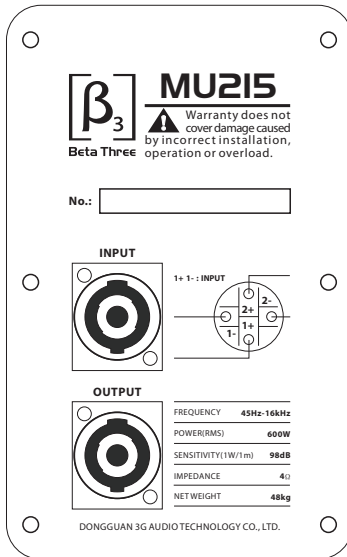

1+ 1- INPUT

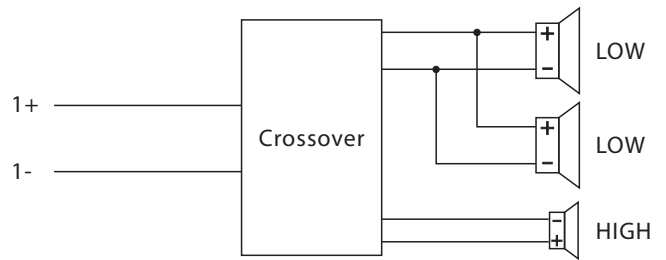

**NL4 Connection**

1. Connect

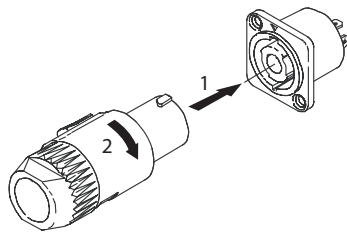

2. Disconnect

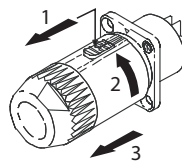

**System Connection Reference**

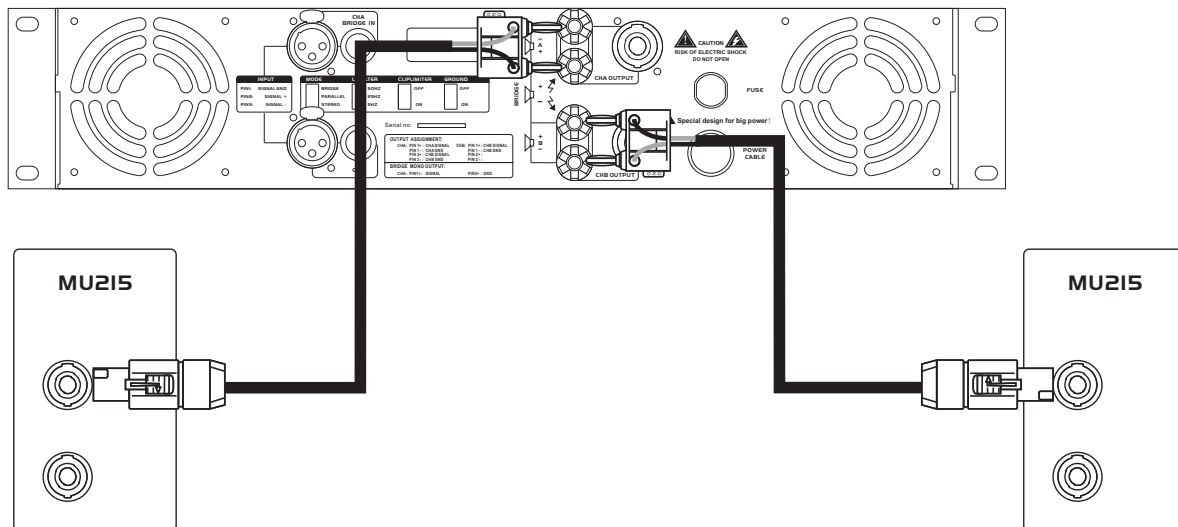

- ⚠ Attention:** The impedance of connected speaker must match the impedance of amplifier output.
- ⚠ Attention:** Make sure the polarity of speaker and amplifier correctly.

## Speaker Wiring

1. Banana plugs to NL4

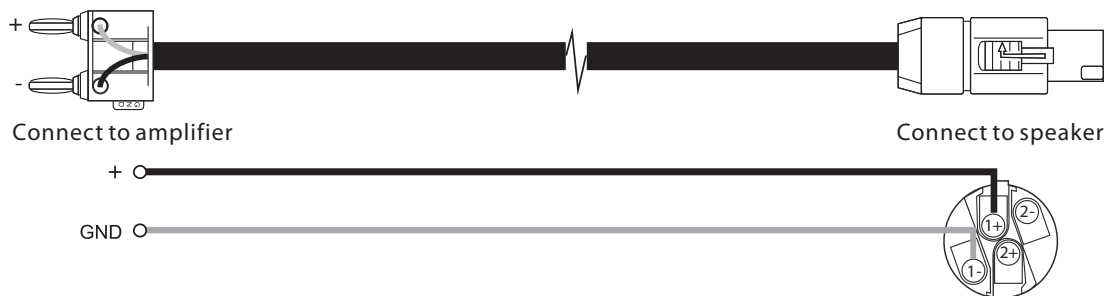

2. NL4 to NL4

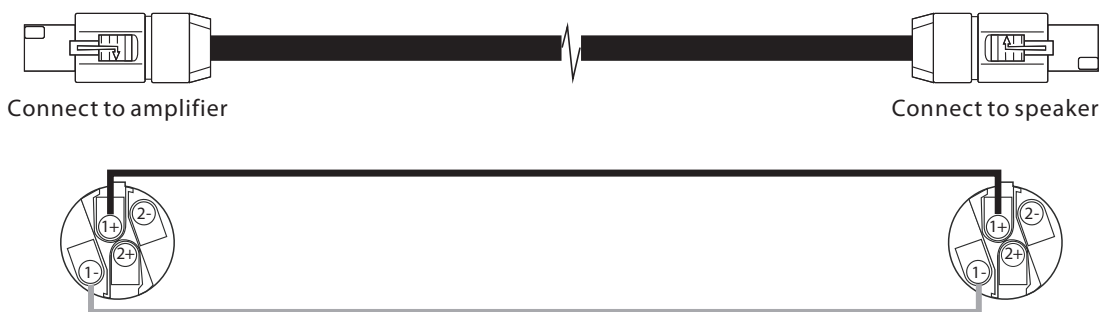

3. Consumption curve of connection cable(Only for reference, the result is different if adopting the different cables)

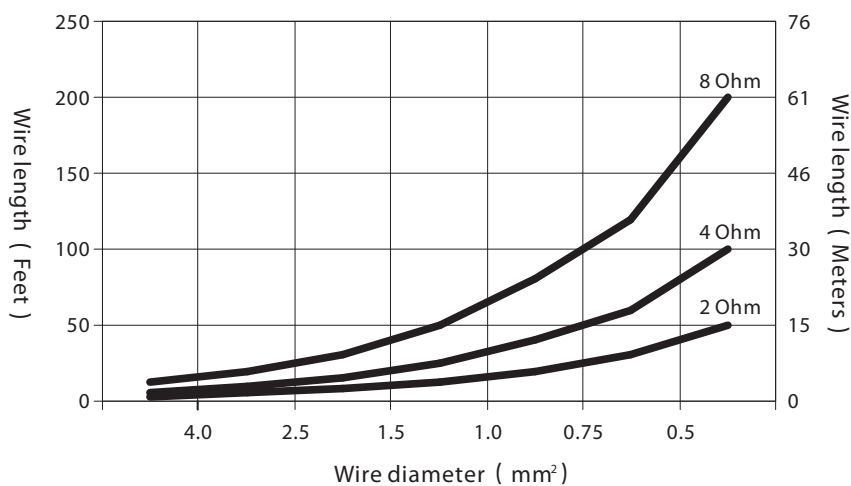

**Mounting Accessories(Optional)**

The standard flying mounting hardware is very convenient for different installation and applications.

1. Standard flying mounting ring

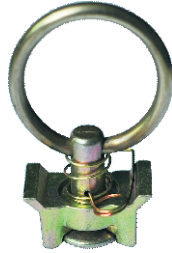

2. Mobile Caster

- Caster:  $\phi$  100 \*34mm 2 pcs
- Screws: M8 \*30 Hexagon 8 pcs
- Spring washers:  $\phi$  8 (Black) 8 pcs
- Flat pad:  $\phi$  8 (Black) 8 pcs
- PE bag: 2 pcs
- Carton: 1 pc

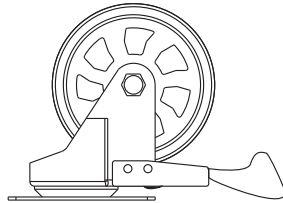

Transportation reference

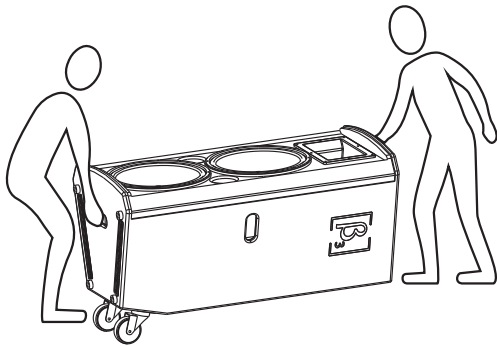

**Installation Reference**

1. Vertical flying mounting installation:

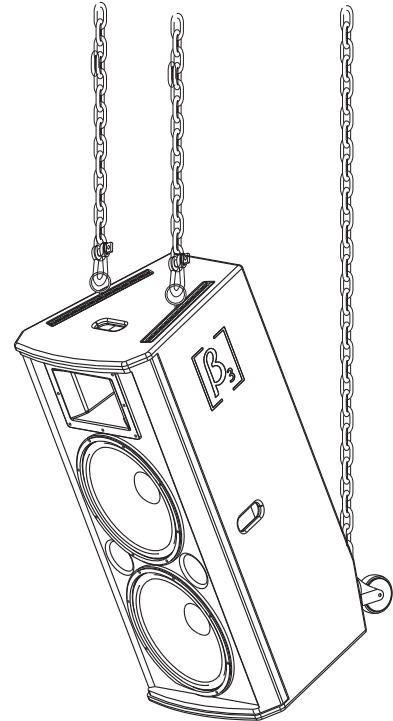

2. Horizontal flying mounting installation:

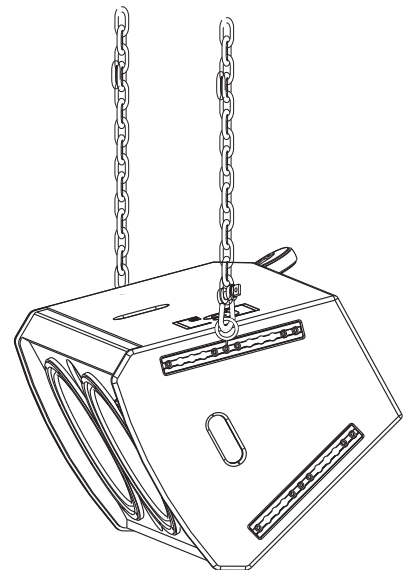

**Warning:** Make sure the mounting accessories safety factor not less than 5:1 or meet the local standard during installation .

**Specification**

<b>System:</b>	Passive full range wooden speaker with painting
<b>Tweeter:</b>	1 x 3" Compression Driver
<b>Woofer:</b>	2 x 15" Neodymium woofers
<b>Frequency response(-3dB):<sup>1</sup></b>	45Hz-16kHz
<b>Frequency response(-10dB):</b>	40Hz-20kHz
<b>Sensitivity(1W@1m):<sup>2</sup></b>	98dB
<b>Max.SPL(1m):</b>	126dB/132dB(PEAK)
<b>Power:</b>	600W (RMS) <sup>4</sup> 1200W (MUSIC) 2400W (PEAK)
<b>Dispersion ( H x V ) :</b>	90 ° x 40 °
<b>Rated impedance:</b>	4 Ohms
<b>Crossover point:</b>	1.8kHz
<b>Cabinet:</b>	Wedge shape
<b>Mounting accessories:</b>	Fixed supporting base
<b>Handle:</b>	4 x Wooden handles
<b>Painting:</b>	Cabinet coated by Polyurethane paint; grille is powder coated
<b>Connector:</b>	NL4 x 2
<b>Cabinet dimension:</b>	530 x 530 x 1075mm (20.9 x 20.9 x 42.3in)
<b>Package dimension:</b>	660 x 660 x 1195mm (26.0 x 26.0 x 47.0in)
<b>N.W.(pc):</b>	48.0kg(105.6 lb)
<b>G.W.(pc):</b>	56.5kg(124.3 lb)
<b>Optional mounting accessories:</b>	Speaker stand

**Speaker Testing Method**

**1. Frequency Response**

Use Pink noise to test the speaker in the anechoic chamber, adjust the level to make the speaker work at its rated impedance and set the output power at 1W, then test the frequency response 1m away from the speaker.

**2. Sensitivity**

Use full range Pink noise which has been modified using an EQ curve to test the speaker in the anechoic chamber, increasing the signal to make the speaker work at its rated impedance and set the power output at 1W, then test the sensitivity 1m away from the speaker.

**3. MAX.SPL**

Use full range Pink noise which has been modified using an EQ curve to test the speaker in the anechoic chamber, increase the signal to make the speaker work at its maximum power output level, then test the SPL 1m away from the speaker.

**4. Rated Power**

Use Pink noise to the IEC#268-5 standard to test the speaker, increase the signal for a continuous period of 100 hours, the rated power is the power when the speaker will show no visible or measurable damage.

**Frequency response curve & Impedance curve**

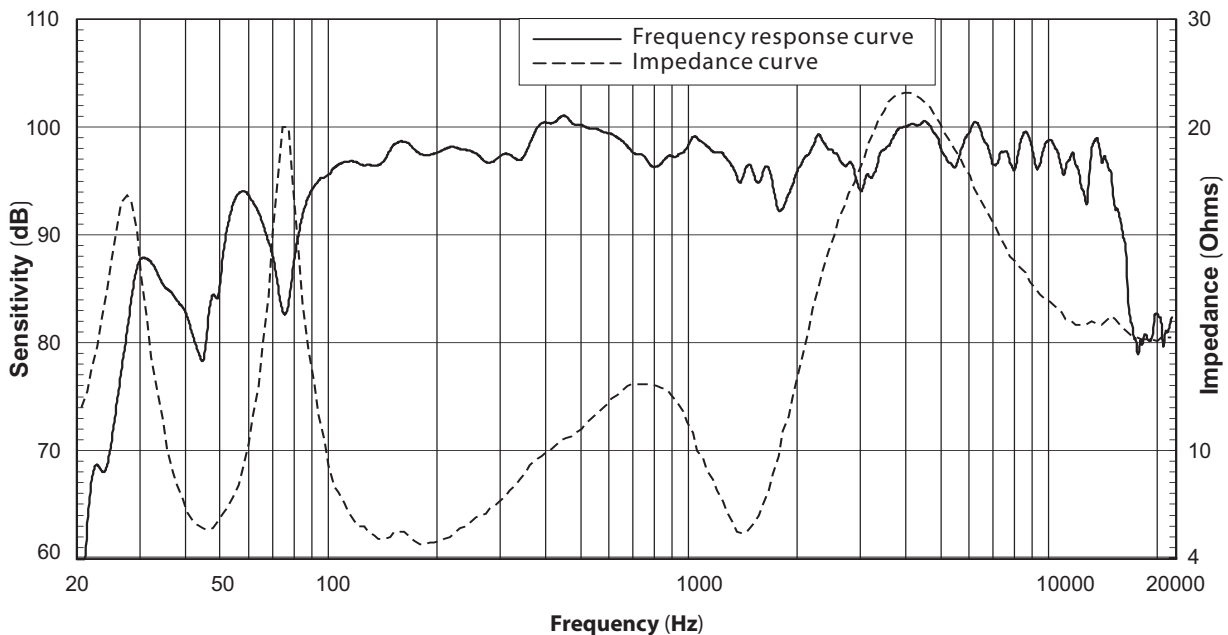



**2D Dimension**

Top view

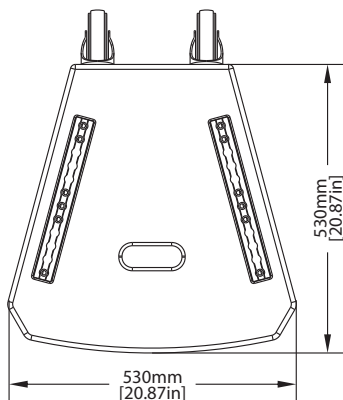

Side view

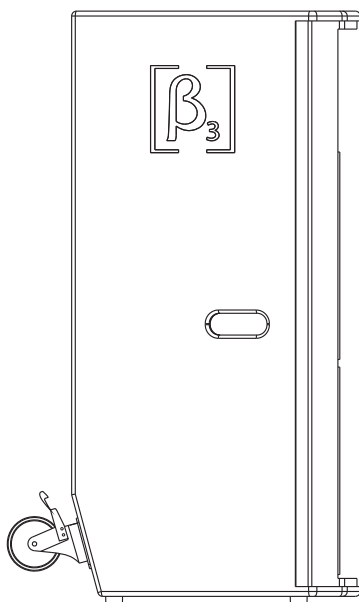

Front view

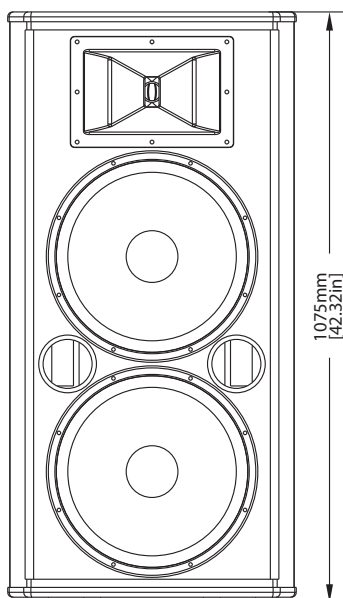

Back view

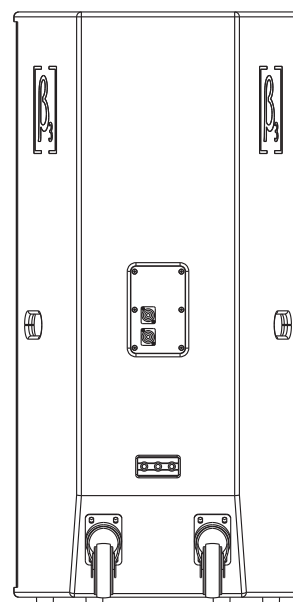

Bottom view

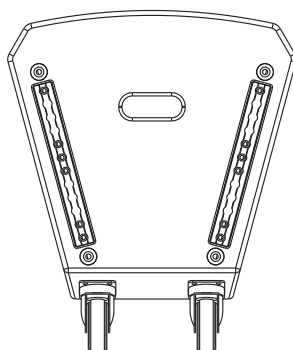

**Notes:**



**Beta Three**

[www.beta3pro.com](http://www.beta3pro.com).