



Beta Three

# TW215a

Dual 15" Two Way Full  
Range Active Speaker

TW Series Pro Loudspeaker System

## User Manual

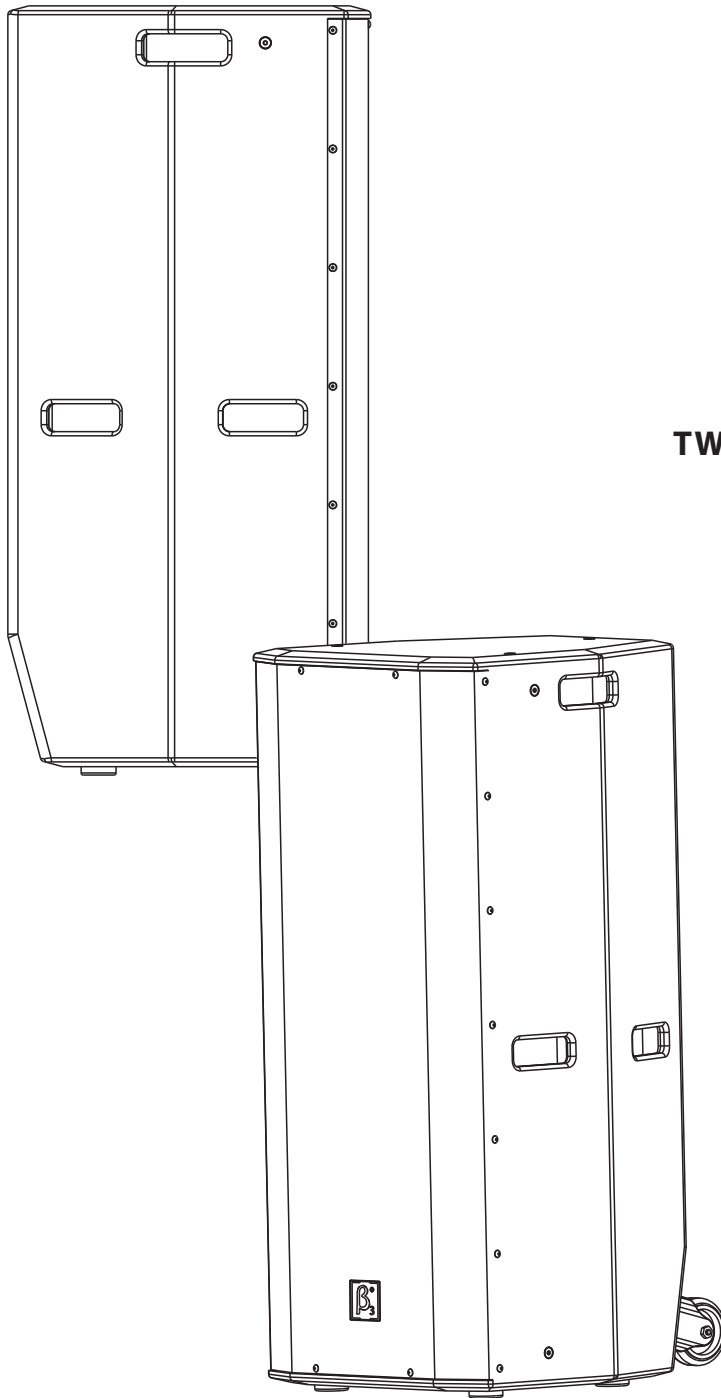





UM-TW215a-20130703 ver A



# SAFETY INSTRUCTIONS

## PLEASE READ THIS MANUAL FIRST

Thanks for buying  $\beta_3$  products. Read this manual first as it will help you operate the system properly. Please keep this manual for future reference.

-  **WARNING:** *This product must be installed by professionals. When using the hanging and rigging parts that are not appointed, please ensure the intensity of the structure comply with the local safety criterion.*
-  **WARNING:** *To reduce the risk of fire or electric shock, do not expose this apparatus to rain or moisture.*
-  **WARNING:** *To reduce the risk of electric shock, only qualified professionals can remove the cover of this system.*

	<b>CAUTION</b> RISK OF ELECTRICAL SHOCK DO NOT OPEN	
CAUTION: TO REDUCE THE RISK OF ELECTRIC SHOCK, DO NOT REMOVE COVER (OR BACK). NO USER-SERVICABLE PARTS INSIDE. REFER SERVICING TO QUALIFIED PERSONNEL.		





	<b>AVIS</b> RISQUE DE CHOC ÉLECTRIQUE NE PAS OUVRIR	
ATTENTION : POUR RÉDUIRE LE RISQUE DE DÉCHARGE ÉLECTRIQUE, NE RETIREZ PAS LE COUVERCLE (OU L'ARRIÈRE). IL NE SE TROUVE À L'INTÉRIEUR AUCUNE PIÈCE POUVANT ÊTRE RÉPARÉE PAR L'USAGER. S'ADRESSER À UN RÉPARATEUR COMPÉTENT.		



*The lightning flash & arrowhead symbol within an equilateral triangle is intended to alert you that this part is not dielectric, and may cause the hazard of electric shock.*



*The exclamation point within an equilateral triangle is intended to alert you to the presence of important operating and servicing instructions.*

-  **ATTENTION:** *This system must be connected to the output socket with grounded thread.*
-  **ATTENTION:** *Don't refit the system or spare parts without being authorized as this will cause the hidden trouble.*
-  **WARNING:** *Don't lay the fire source (such as litten candle) above the equipment.*
-  **ATTENTION:** *Please operate cautiously even when the main socket or the coupling apparatus is used as disconnection equipment.*

1. Read this instruction first before using this product.
2. Please keep this manual for future reference
3. Pay attention to all warnings.
4. Obey all operating instructions.
5. Do not expose this product to rain or moisture.
6. Smear this equipment with dry cloth.
7. Do not block any ventilation openings. Install according to instructions of the manufacturer.
8. Do not install this product near any heat source, such as caliduct, heater, burner, or any other equipment with heat radiation (include amplifier).
9. Do not destroy the safety settings of the polarity or grounded connector. If the connector provided can't be plugged into the socket, please ask for the electrician to change the socket.
10. Avoid the thread (especially the connector, socket, and the parts outside the body) to be under kick or heavily hustled.
11. Only use spare parts appointed by manufacturer.
12. Please only use cart, stand, tripod, bracket and table that are appointed by manufacturer or sold together with the apparatus. Please avoid overturn the cart or apparatus when push.
13. In the event of lighting flash or nonuse for a long period, please put off the power supply and pull out the cord to avoid unexpected dangers.
14. When the apparatus damages in the case of the power cord or connector damages, liquids spill into the inside of the product or objects fall into, exposure to rain or moisture, apparatus are out of work or breaks, please ask for the help from the professionals.
15. To avoid hazard of fire or electric shock, please avoid socket, extend thread, and power supply been overloaded.
16. Take care that objects do not fall into and that liquids are not spilled into the inside of the product as this will cause hazard of fire or electric shock.
17. Pay attention to the safety symbol in the outer side of the cover.
18. Only plug the connector in proper power supply of which the voltage complies with this equipment. Please follow the operating instruction or symbol.
19. This equipment must be protected from the spill or insufflations of liquid. Do not lay objects filled with liquid (such as vase) above this equipment.



**CONTENT**

<b>INTRODUCTION</b>	3
Features	3
Description	3
Application	3
<b>AMPLIFIER MODULE</b>	4
Amplifier Module	4
<b>INSTALLATION</b>	5
Installation Accessories	5
Installation Reference	5
<b>TECHNICAL SPECIFICATION</b>	6
Technical Sheet	6
Frequency Response	6
2D Dimension	7

 Product information may be updated without notification, please visit [www.elderaudio.com](http://www.elderaudio.com) for latest update.

## TW215a

Dual 15" Two Way Full Range Active Speaker

### Features

- Compact lightweight design with unique appearance.
- New generation Class D amplifier, durable and reliable.
- Performance enhanced with built-in DSP.
- High output SPL and sensitivity.
- Suitable for use as a main system with or without sub speaker augmentation.
- Master volume control.
- Durable Polyurethane textured base paint.

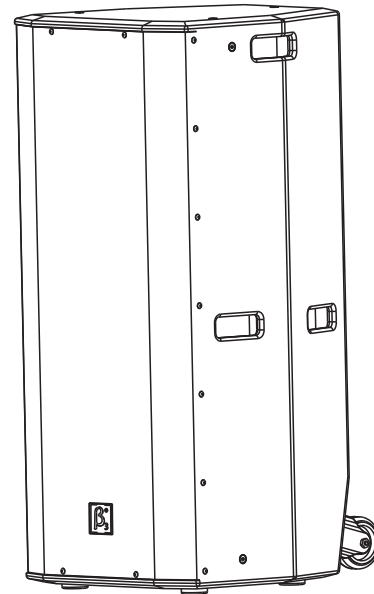

### Description

β<sup>3</sup> TW215a is a full range active speaker in TW family. It has dual 15" Cloth edge woofers and 3" compression driver. The compression driver is using a new material magnalium, the single 15 woofer has 3" round copper wire voice coil which can delivery 300W power ,the woofer symmetrical magnet cir-cuit design reduce the impar HD effectively and enhance the LF sound quality.

TW215a is a dual-channel active speaker with internal crossover. One channel is class D amp circuit with big peak power handling, which is used for driving LF. The power is 1300W/4Ω. Another channel is using 7294 IC for driving HF, which has low distortion, big power and higher reliability.

Cabinet is made of 18mm plywood with advanced environmental protection by using Polyurethane-based painting which is very rigid. The cabinet strength reach to 4500N. Q235 grille is coated by powder to provide strong ultra-Weatherability, canbe used outdoors for 5 years. The backside foam of grille can prevent the rain.

TW215a has the protection free design, which reduces the interference and enhance the sound quality. TW215a is mainly designed for conference room, multifunctional hall, auditorium, church, living performance.

The TW215a has two 4" optional wheels available for mobile application.

### Applications

- Church
- Auditorium
- Small Performance
- Multifunctional Hall
- Medium Conference Room

**Amplifier Module**

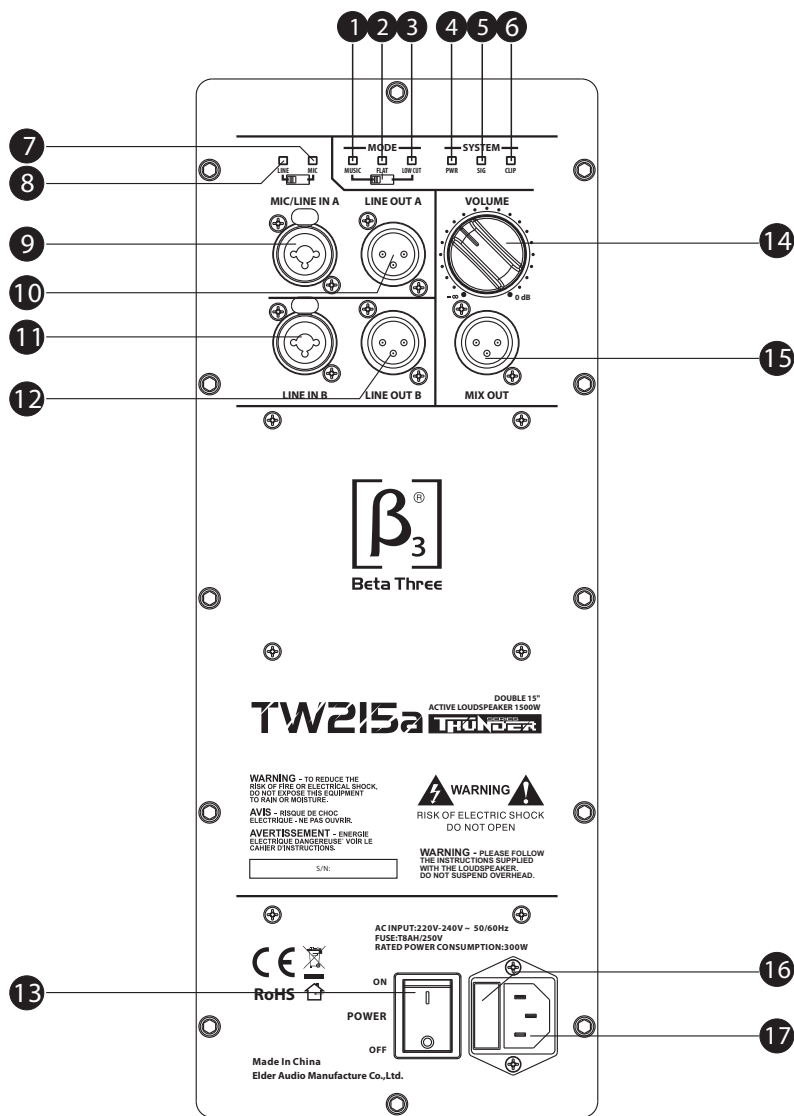

- |                                       |                                 |   |
|---------------------------------------|---------------------------------|---|
| 1. Music mode                         | 8. Line input signal indicator. | 15. MIX output.   |
| 2. Flat mode                          | 9. Line/microphone input A.     | 16. Protection fuse. Use only fuse of the correct amp rating.                                 |
| 3. Low cut mode                       | 10. Line/microphone output A.   | 17. Power supply input. Make sure that the voltage is set for your country's correct voltage. |
| 4. Power indicator                    | 11. Line input B.               |   |
| 5. Signal indicator                   | 12. Line output B.              |   |
| 6. Clip indicator                     | 13. Power <b>ON/OFF</b> switch. |   |
| 7. Microphone input signal indicator. | 14. Volume control.             |   |

**⚠ Attention :** Before changing the MODE switch, please power the speaker off to avoid possible damage.

## Mounting Accessories(Optional)

The standard flying mounting hardware is very convenient for different installation and applications.

### 1. Mobile Caster

- Caster:  $\phi 100 * 34\text{mm}$  2 pcs
- Screws: M8 \* 30 Hexagon 8 pcs
- Spring washers:  $\phi 8$  (Black) 8 pcs
- Flat pad:  $\phi 8$  (Black) 8 pcs
- PE bag: 2 pcs
- Carton: 1 pc

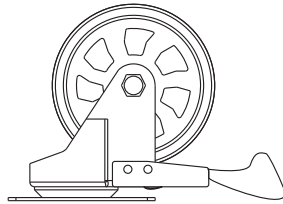

### Transportation reference

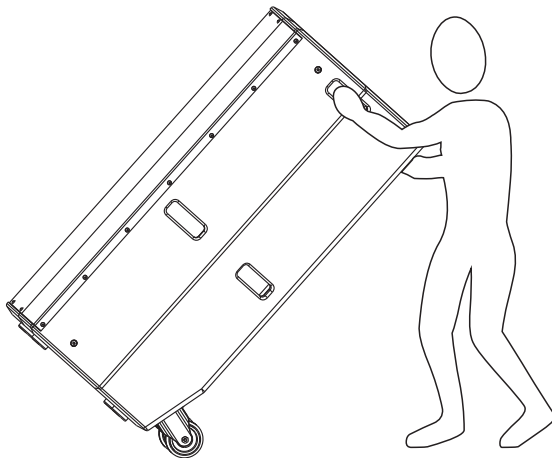

## Installation Reference

### 1. Vertical flying mounting installation:

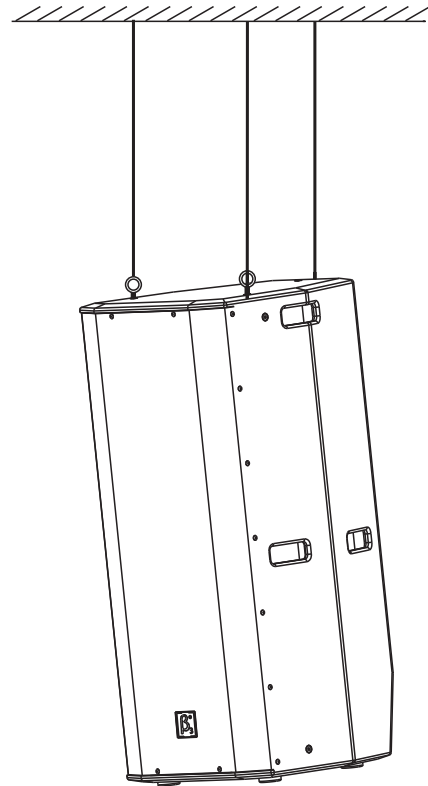

**Warning:** Make sure the mounting accessories safety factor not less than 5:1 or meet the local standard during installation .

**Specification**

Frequency response(-3dB):	45Hz-18kHz
Max.SPL:	128dB
Dispersion(H×V):	50°×55°
Transducer:	2× 15" Woofer 1× 3" Compression Driver
Rated impedance:	4 Ohms
Connector:	XLR for input, XLR for output
Input:	Channel one (Mic/Line) balanced input
Input impedance(line):	20Kohm balanced input, 2Kohm unbalanced input
Input level:	0 dBV (0.775V rms, 1.0 V peak)Line-100Hz
Input overloading level:	Maximum input level 8V peak
Wire connection:	pin 1: ground; pin2: signal +; pin3: signal -
Heat radiation:	Forced air-cooled drives
Power cable:	IEC 3 pin power connector
Safety voltage range:	AC 220V-240V~50/60Hz
Amplifier power output:	1500W
Cabinet:	Plywood
Mounting accessories:	11×M10 hanging point
Handle:	6× Wooden handles
Painting:	Cabinet coated by Polyurethane paint; grille is powder coated
Cabinet dimension(W×D×H):	520×520×1090mm(20.5×20.5×42.9in)
Packing dimension(W×D×H):	650×650×1240mm(25.6×25.6×48.8in)
Net weight:	53.0kg(116.6 lb)
Gross weight:	60.0kg(132.0 lb)

**Frequency response curve**

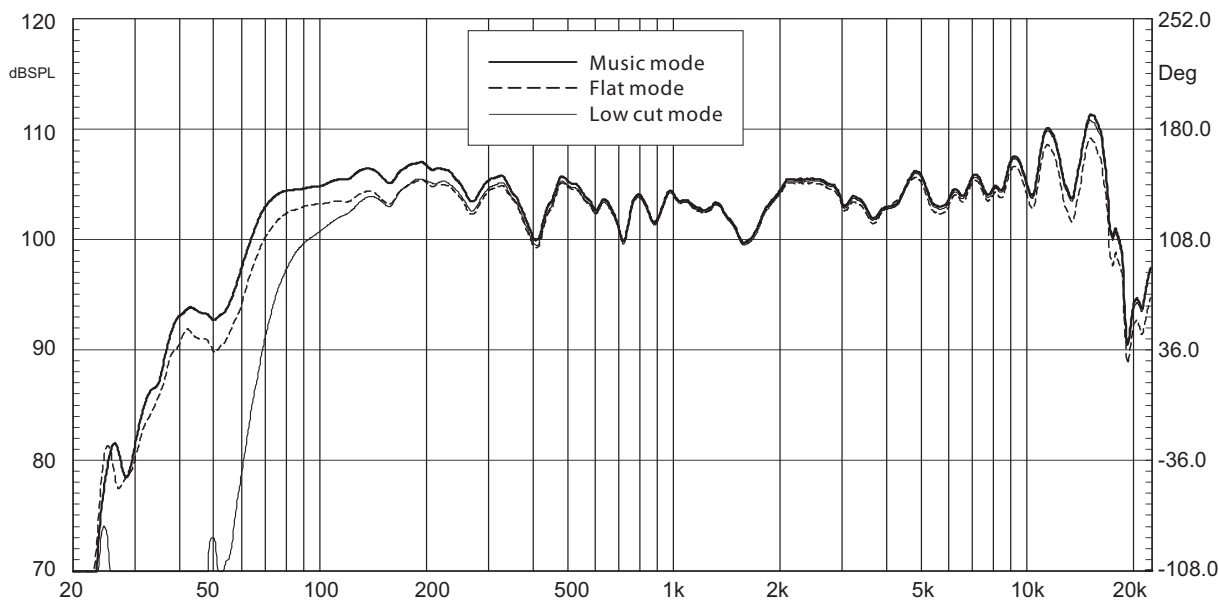

2D Dimension

Top view

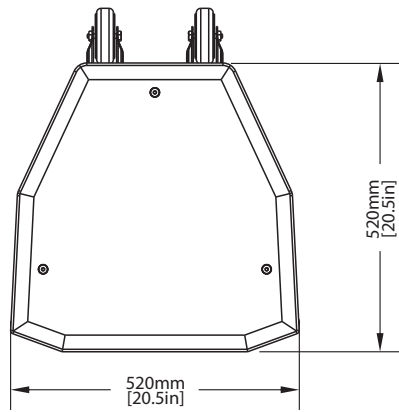

Side view

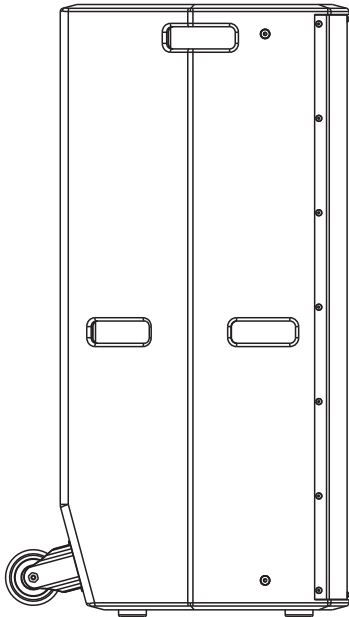

Front view

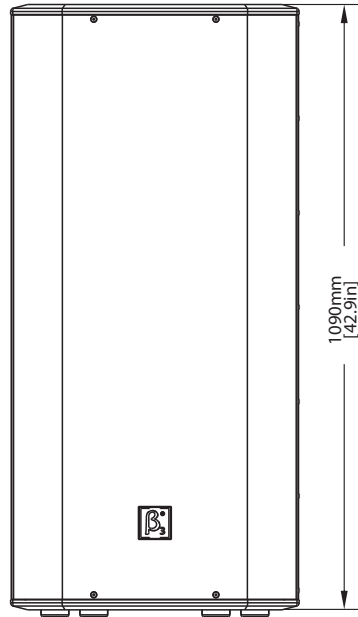

Back view

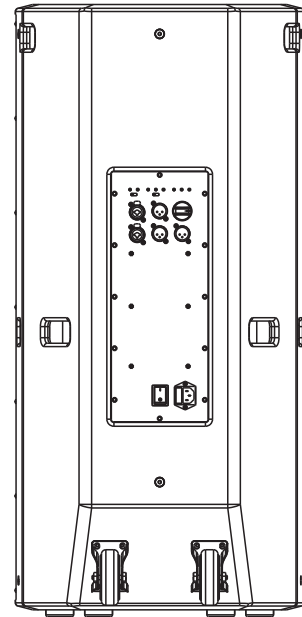

Bottom view

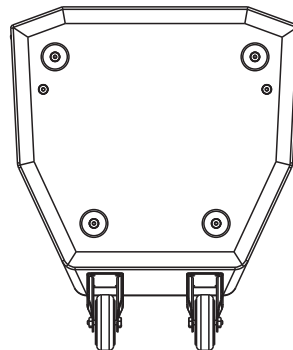



**Notes:**



**Beta Three**